

## FEATURES

- **Smallest Pin-Compatible Octal DACs:**
  - LTC2600: 16 Bits**
  - LTC2610: 14 Bits**
  - LTC2620: 12 Bits**
- **Guaranteed 16-Bit Monotonic Over Temperature**
- Wide 2.5V to 5.5V Supply Range
- Low Power Operation: 250 $\mu$ A per DAC at 3V
- Individual Channel Power-Down to 1 $\mu$ A, Max
- Ultralow Crosstalk Between DACs (<10 $\mu$ V)
- High Rail-to-Rail Output Drive ( $\pm$ 15mA, Min)
- Double-Buffered Digital Inputs
- Pin-Compatible 10-/8-Bit Versions (LTC1660/LTC1665)
- Tiny 16-Lead Narrow SSOP and 20-Lead 4mm  $\times$  5mm QFN Packages

## APPLICATIONS

- Mobile Communications
- Process Control and Industrial Automation
- Instrumentation
- Automatic Test Equipment

## DESCRIPTION

The LTC<sup>®</sup>2600/LTC2610/LTC2620 are octal 16-, 14- and 12-bit, 2.5V-to-5.5V rail-to-rail voltage-output DACs in 16-lead narrow SSOP and 20-lead 4mm  $\times$  5mm QFN packages. They have built-in high performance output buffers and are guaranteed monotonic.

These parts establish new board-density benchmarks for 16- and 14-bit DACs and advance performance standards for output drive, crosstalk and load regulation in single-supply, voltage-output multiples.

The parts use a simple SPI/MICROWIRE compatible 3-wire serial interface which can be operated at clock rates up to 50MHz. Daisychain capability and a hardware CLR function are included.

The LTC2600/LTC2610/LTC2620 incorporate a power-on reset circuit. During power-up, the voltage outputs rise less than 10mV above zero-scale; and after power-up, they stay at zero-scale until a valid write and update take place.

LT, LT, LTC, LTM, Linear Technology and the Linear logo are registered trademarks of Linear Technology Corporation. All other trademarks are the property of their respective owners.

## BLOCK DIAGRAM

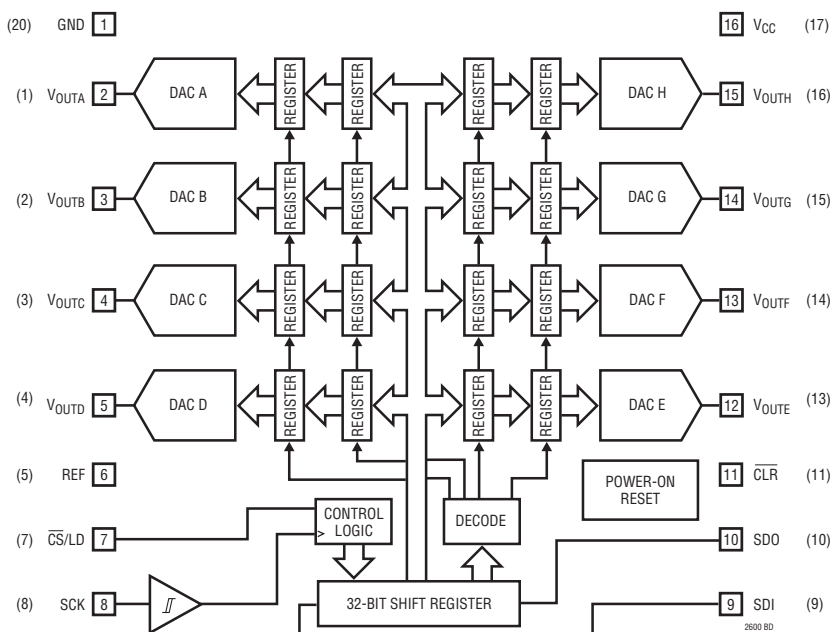

NOTE: NUMBERS IN PARENTHESIS REFER TO THE UFD PACKAGE

Differential Nonlinearity (LTC2600)

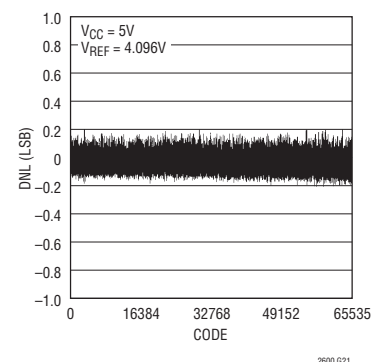

# LTC2610

## ABSOLUTE MAXIMUM RATINGS (Note 1)

Any Pin to GND .....	-0.3V to 6V	Storage Temperature Range.....	-65°C to 150°C
Any Pin to V <sub>CC</sub> .....	-6V to 0.3V	Maximum Junction Temperature.....	125°C
Operating Temperature Range		Lead Temperature (Soldering, 10 sec) .....	300°C
LTC2600C/LTC2610C/LTC2620C .....	0°C to 70°C		
LTC2600I/LTC2610I/LTC2620I.....	-40°C to 85°C		

## PIN CONFIGURATION

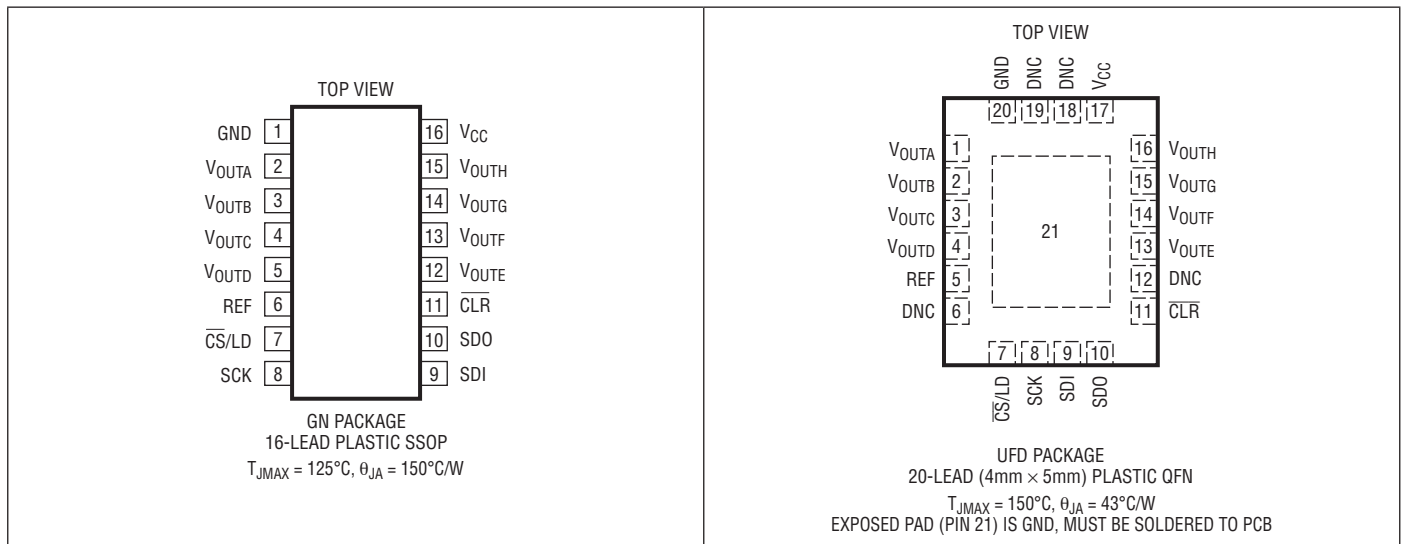

## ORDER INFORMATION

LEAD FREE FINISH	TAPE AND REEL	PART MARKING*	PACKAGE DESCRIPTION	TEMPERATURE RANGE
LTC2600CUFD#PBF	LTC2600CUFD#TRPBF	2600	20-Lead (4mm × 5mm) Plastic DFN	0°C to 70°C
LTC2600IUFD#PBF	LTC2600IUFD#TRPBF	2600	20-Lead (4mm × 5mm) Plastic DFN	-40°C to 85°C
LTC2600CGN#PBF	LTC2600CGN#TRPBF	2600	16-Lead Plastic SSOP	0°C to 70°C
LTC2600IGN#PBF	LTC2600IGN#TRPBF	2600I	16-Lead Plastic SSOP	-40°C to 85°C
LTC2610CUFD#PBF	LTC2610CUFD#TRPBF	2610	20-Lead (4mm × 5mm) Plastic DFN	0°C to 70°C
LTC2610IUFD#PBF	LTC2610IUFD#TRPBF	2610	20-Lead (4mm × 5mm) Plastic DFN	-40°C to 85°C
LTC2610CGN#PBF	LTC2610CGN#TRPBF	2610	16-Lead Plastic SSOP	0°C to 70°C
LTC2610IGN#PBF	LTC2610IGN#TRPBF	2610I	16-Lead Plastic SSOP	-40°C to 85°C
LTC2620CUFD#PBF	LTC2620CUFD#TRPBF	2620	20-Lead (4mm × 5mm) Plastic DFN	0°C to 70°C
LTC2620IUFD#PBF	LTC2620IUFD#TRPBF	2620	20-Lead (4mm × 5mm) Plastic DFN	-40°C to 85°C
LTC2620CGN#PBF	LTC2620CGN#TRPBF	2620	16-Lead Plastic SSOP	0°C to 70°C
LTC2620IGN#PBF	LTC2620IGN#TRPBF	2620I	16-Lead Plastic SSOP	-40°C to 85°C

Consult LTC Marketing for parts specified with wider operating temperature ranges. \*The temperature grade is identified by a label on the shipping container. Consult LTC Marketing for information on non-standard lead based finish parts.

For more information on lead free part marking, go to: <http://www.linear.com/leadfree/>

For more information on tape and reel specifications, go to: <http://www.linear.com/tapeandreeel/>

## ELECTRICAL CHARACTERISTICS

The ● denotes specifications which apply over the full operating temperature range, otherwise specifications are at  $T_A = 25^\circ\text{C}$ .  $V_{CC} = 2.5\text{V}$  to  $5.5\text{V}$ ,  $V_{REF} \leq V_{CC}$ ,  $V_{OUT}$  unloaded, unless otherwise noted.

SYMBOL	PARAMETER	CONDITIONS	LTC2620			LTC2610			LTC2600			UNITS
			MIN	TYP	MAX	MIN	TYP	MAX	MIN	TYP	MAX	
<b>DC Performance</b>												
	Resolution		●	12		14		16				Bits
	Monotonicity	$V_{CC} = 5\text{V}$ , $V_{REF} = 4.096\text{V}$ (Note 2)	●	12		14		16				Bits
DNL	Differential Nonlinearity	$V_{CC} = 5\text{V}$ , $V_{REF} = 4.096\text{V}$ (Note 2)	●		$\pm 0.5$		$\pm 1$		$\pm 1$			LSB
INL	Integral Nonlinearity	$V_{CC} = 5\text{V}$ , $V_{REF} = 4.096\text{V}$ (Note 2)	●	$\pm 0.75$	$\pm 4$		$\pm 3$	$\pm 16$		$\pm 12$	$\pm 64$	LSB
	Load Regulation	$V_{REF} = V_{CC} = 5\text{V}$ , Mid-Scale $I_{OUT} = 0\text{mA}$ to $15\text{mA}$ Sourcing $I_{OUT} = 0\text{mA}$ to $15\text{mA}$ Sinking	●	0.025	0.125		0.1	0.5		0.3	2	LSB/mA
		$V_{REF} = V_{CC} = 2.5\text{V}$ , Mid-Scale $I_{OUT} = 0\text{mA}$ to $7.5\text{mA}$ Sourcing $I_{OUT} = 0\text{mA}$ to $7.5\text{mA}$ Sinking	●	0.05	0.25		0.2	1		0.8	4	LSB/mA
ZSE	Zero-Scale Error	$V_{CC} = 5\text{V}$ , $V_{REF} = 4.096\text{V}$ Code = 0		1	9		1	9		1	9	mV
$V_{OS}$	Offset Error	$V_{CC} = 5\text{V}$ , $V_{REF} = 4.096\text{V}$ (Note 7)		$\pm 1$	$\pm 9$		$\pm 1$	$\pm 9$		$\pm 1$	$\pm 9$	mV
	$V_{OS}$ Temperature Coefficient			$\pm 3$			$\pm 3$			$\pm 3$		$\mu\text{V}/^\circ\text{C}$
GE	Gain Error	$V_{CC} = 5\text{V}$ , $V_{REF} = 4.096\text{V}$		$\pm 0.2$	$\pm 0.7$		$\pm 0.2$	$\pm 0.7$		$\pm 0.2$	$\pm 0.7$	%FSR
	Gain Temperature Coefficient			$\pm 6.5$			$\pm 6.5$			$\pm 6.5$		ppm/ $^\circ\text{C}$

The ● denotes specifications which apply over the full operating temperature range, otherwise specifications are at  $T_A = 25^\circ\text{C}$ .  $V_{CC} = 2.5\text{V}$  to  $5.5\text{V}$ ,  $V_{REF} \leq V_{CC}$ ,  $V_{OUT}$  unloaded, unless otherwise noted.

SYMBOL	PARAMETER	CONDITIONS	LTC2600/LTC2610/LTC2620			UNITS	
			MIN	TYP	MAX		
PSR	Power Supply Rejection	$V_{CC} = \pm 10\%$		-80		dB	
$R_{OUT}$	DC Output Impedance	$V_{REF} = V_{CC} = 5\text{V}$ , Mid-Scale; $-15\text{mA} \leq I_{OUT} \leq 15\text{mA}$	●	0.025	0.15	$\Omega$	
		$V_{REF} = V_{CC} = 2.5\text{V}$ , Mid-Scale; $-7.5\text{mA} \leq I_{OUT} \leq 7.5\text{mA}$	●	0.030	0.15	$\Omega$	
	DC Crosstalk (Note 4)	Due to Full-Scale Output Change (Note 5) Due to Load Current Change Due to Powering Down (per Channel)		$\pm 10$		$\mu\text{V}$	
			$\pm 3.5$		$\mu\text{V}/\text{mA}$		
			$\pm 7.3$		$\mu\text{V}$		
$I_{SC}$	Short-Circuit Output Current	$V_{CC} = 5.5\text{V}$ , $V_{REF} = 5.6\text{V}$ Code: Zero-Scale; Forcing Output to $V_{CC}$ Code: Full-Scale; Forcing Output to GND	●	15	34	60	mA
			●	15	34	60	mA
		$V_{CC} = 2.5\text{V}$ , $V_{REF} = 5.6\text{V}$ Code: Zero-Scale; Forcing Output to $V_{CC}$ Code: Full-Scale; Forcing Output to GND	●	7.5	18	50	mA
			●	7.5	24	50	mA

### Reference Input

	Input Voltage Range		●	0	$V_{CC}$	V	
	Resistance	Normal Mode	●	11	16	20	k $\Omega$
	Capacitance			90		pF	
$I_{REF}$	Reference Current, Power-Down Mode	All DACs Powered Down	●	0.001	1	$\mu\text{A}$	

# LTC2610

## ELECTRICAL CHARACTERISTICS

The ● denotes specifications which apply over the full operating temperature range, otherwise specifications are at  $T_A = 25^\circ\text{C}$ .  $V_{CC} = 2.5\text{V to } 5.5\text{V}$ ,  $V_{REF} \leq V_{CC}$ ,  $V_{OUT}$  unloaded, unless otherwise noted.

SYMBOL	PARAMETER	CONDITIONS	LTC2600/LTC2610/LTC2620			UNITS
			MIN	TYP	MAX	
<b>Power Supply</b>						
$V_{CC}$	Positive Supply Voltage		● 2.5		5.5	V
$I_{CC}$	Supply Current	$V_{CC} = 5\text{V}$ (Note 3)	●	2.6	4	mA
		$V_{CC} = 3\text{V}$ (Note 3)	●	2.0	3.2	mA
		All DACs Powered Down (Note 3) $V_{CC} = 5\text{V}$	●	0.35	1	$\mu\text{A}$
		All DACs Powered Down (Note 3) $V_{CC} = 3\text{V}$	●	0.10	1	$\mu\text{A}$
<b>Digital I/O</b>						
$V_{IH}$	Digital Input High Voltage	$V_{CC} = 2.5\text{V to } 5.5\text{V}$	●	2.4		V
		$V_{CC} = 2.5\text{V to } 3.6\text{V}$	●	2.0		V
$V_{IL}$	Digital Input Low Voltage	$V_{CC} = 4.5\text{V to } 5.5\text{V}$	●		0.8	V
		$V_{CC} = 2.5\text{V to } 5.5\text{V}$	●		0.6	V
$V_{OH}$	Digital Output High Voltage	Load Current = $-100\mu\text{A}$	●	$V_{CC} - 0.4$		V
$V_{OL}$	Digital Output Low Voltage	Load Current = $+100\mu\text{A}$	●		0.4	V
$I_{LK}$	Digital Input Leakage	$V_{IN} = \text{GND to } V_{CC}$	●		$\pm 1$	$\mu\text{A}$
$C_{IN}$	Digital Input Capacitance	(Note 6)	●		8	pF

The ● denotes specifications which apply over the full operating temperature range, otherwise specifications are at  $T_A = 25^\circ\text{C}$ .  $V_{CC} = 2.5\text{V to } 5.5\text{V}$ ,  $V_{REF} \leq V_{CC}$ ,  $V_{OUT}$  unloaded, unless otherwise noted.

SYMBOL	PARAMETER	CONDITIONS	LTC2620			LTC2610			LTC2600			UNITS
			MIN	TYP	MAX	MIN	TYP	MAX	MIN	TYP	MAX	
<b>AC Performance</b>												
$t_S$	Settling Time (Note 8)	$\pm 0.024\%$ ( $\pm 1\text{LSB}$ at 12 Bits)		7		7		7			$\mu\text{s}$	
		$\pm 0.006\%$ ( $\pm 1\text{LSB}$ at 14 Bits)				9		9			$\mu\text{s}$	
		$\pm 0.0015\%$ ( $\pm 1\text{LSB}$ at 16 Bits)						10			$\mu\text{s}$	
	Settling Time for 1LSB Step (Note 9)	$\pm 0.024\%$ ( $\pm 1\text{LSB}$ at 12 Bits)		2.7		2.7		2.7			$\mu\text{s}$	
		$\pm 0.006\%$ ( $\pm 1\text{LSB}$ at 14 Bits)				4.8		4.8			$\mu\text{s}$	
		$\pm 0.0015\%$ ( $\pm 1\text{LSB}$ at 16 Bits)						5.2			$\mu\text{s}$	
	Voltage Output Slew Rate			0.80		0.80		0.80			V/ $\mu\text{s}$	
	Capacitive Load Driving			1000		1000		1000			pF	
	Glitch Impulse	At Mid-Scale Transition		12		12		12			nV • s	
	Multiplying Bandwidth			180		180		180			kHz	
$e_n$	Output Voltage Noise Density	At $f = 1\text{kHz}$		120		120		120			$\text{nV}/\sqrt{\text{Hz}}$	
		At $f = 10\text{kHz}$		100		100		100			$\text{nV}/\sqrt{\text{Hz}}$	
	Output Voltage Noise	0.1Hz to 10Hz		15		15		15			$\mu\text{V}_{\text{P-P}}$	

## TIMING CHARACTERISTICS

The ● denotes specifications which apply over the full operating temperature range, otherwise specifications are at  $T_A = 25^\circ\text{C}$ . (See Figure 1) (Note 6)

SYMBOL	PARAMETER	CONDITIONS	LTC2600/LTC2610/LTC2620			UNITS
			MIN	TYP	MAX	
<b><math>V_{CC} = 2.5\text{V to }5.5\text{V}</math></b>						
$t_1$	SDI Valid to SCK Setup		●	4		ns
$t_2$	SDI Valid to SCK Hold		●	4		ns
$t_3$	SCK High Time		●	9		ns
$t_4$	SCK Low Time		●	9		ns
$t_5$	$\overline{\text{CS}}/\text{LD}$ Pulse Width		●	10		ns
$t_6$	LSB SCK High to $\overline{\text{CS}}/\text{LD}$ High		●	7		ns
$t_7$	$\overline{\text{CS}}/\text{LD}$ Low to SCK High		●	7		ns
$t_8$	SDO Propagation Delay from SCK Falling Edge	$C_{\text{LOAD}} = 10\text{pF}$ $V_{CC} = 4.5\text{V to }5.5\text{V}$ $V_{CC} = 2.5\text{V to }5.5\text{V}$	● ●		20 45	ns ns
$t_9$	$\overline{\text{CLR}}$ Pulse Width		●	20		ns
$t_{10}$	$\overline{\text{CS}}/\text{LD}$ High to SCK Positive Edge		●	7		ns
	SCK Frequency	50% Duty Cycle	●		50	MHz

**Note 1:** Stresses beyond those listed under Absolute Maximum Ratings may cause permanent damage to the device. Exposure to any Absolute Maximum Rating condition for extended periods may affect device reliability and lifetime.

**Note 2:** Linearity and monotonicity are defined from code  $k_L$  to code  $2N - 1$ , where  $N$  is the resolution and  $k_L$  is given by  $k_L = 0.016(2^N/V_{\text{REF}})$ , rounded to the nearest whole code. For  $V_{\text{REF}} = 4.096\text{V}$  and  $N = 16$ ,  $k_L = 256$  and linearity is defined from code 256 to code 65,535.

**Note 3:** Digital inputs at  $0\text{V}$  or  $V_{CC}$ .

**Note 4:** DC crosstalk is measured with  $V_{CC} = 5\text{V}$  and  $V_{\text{REF}} = 4.096\text{V}$ , with the measured DAC at mid-scale, unless otherwise noted.

**Note 5:**  $R_L = 2\text{k}\Omega$  to GND or  $V_{CC}$ .

**Note 6:** Guaranteed by design and not production tested.

**Note 7:** Inferred from measurement at code 256 (LTC2600), code 64 (LTC2610) or code 16 (LTC2620), and at full-scale.

**Note 8:**  $V_{CC} = 5\text{V}$ ,  $V_{\text{REF}} = 4.096\text{V}$ . DAC is stepped 1/4-scale to 3/4-scale and 3/4-scale to 1/4-scale. Load is 2k in parallel with 200pF to GND.

**Note 9:**  $V_{CC} = 5\text{V}$ ,  $V_{\text{REF}} = 4.096\text{V}$ . DAC is stepped  $\pm 1\text{LSB}$  between half-scale and half-scale - 1. Load is 2k in parallel with 200pF to GND.

## TYPICAL PERFORMANCE CHARACTERISTICS

LTC2600

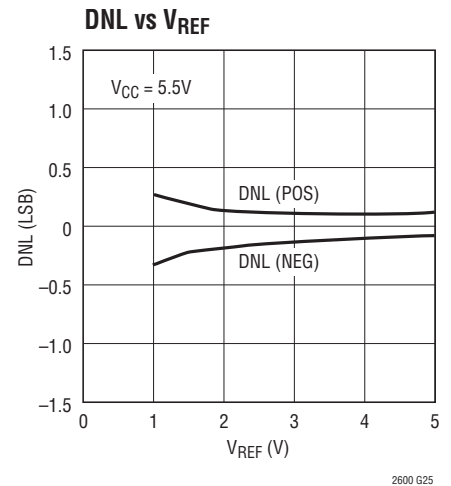
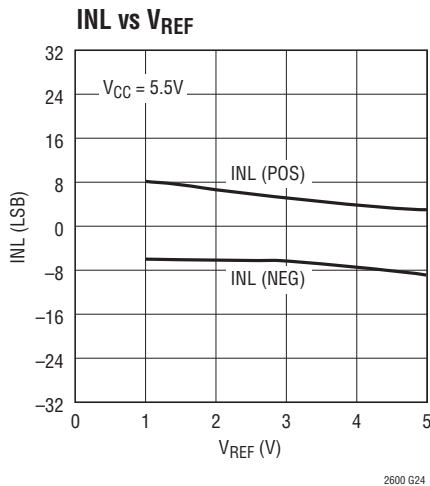
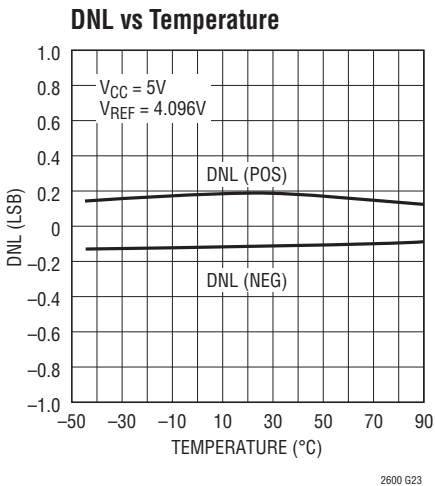
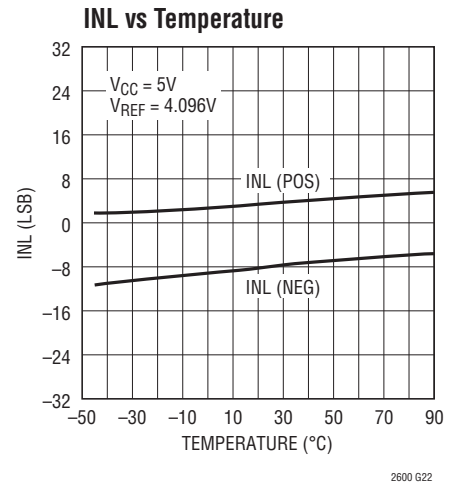
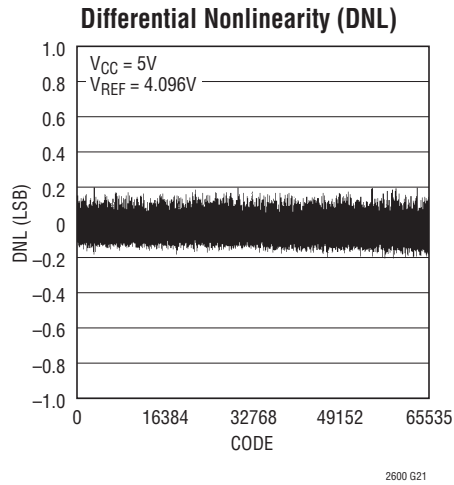
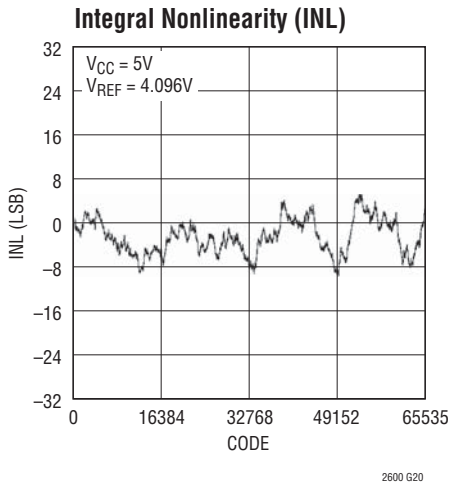

### Settling to $\pm 1LSB$

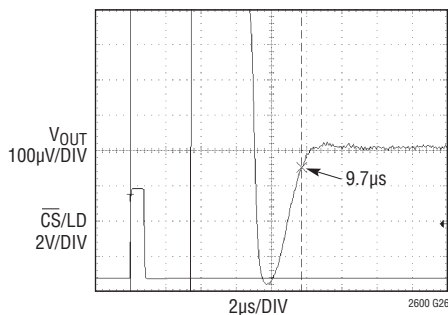

$V_{CC} = 5V$ ,  $V_{REF} = 4.096V$   
1/4-SCALE TO 3/4-SCALE STEP  
 $R_L = 2k$ ,  $C_L = 200pF$   
AVERAGE OF 2048 EVENTS

### Settling of Full-Scale Step

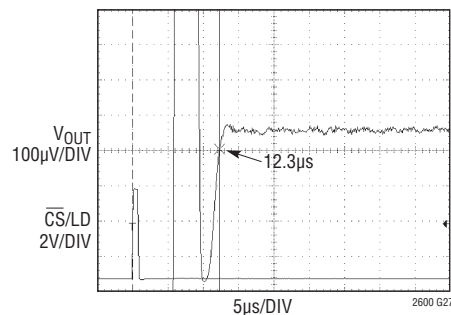

SETTLING TO  $\pm 1LSB$   
 $V_{CC} = 5V$ ,  $V_{REF} = 4.096V$   
CODE 512 TO 65535 STEP  
 $R_L = 2k$ ,  $C_L = 200pF$   
AVERAGE OF 2048 EVENTS

# TYPICAL PERFORMANCE CHARACTERISTICS

## LTC2610

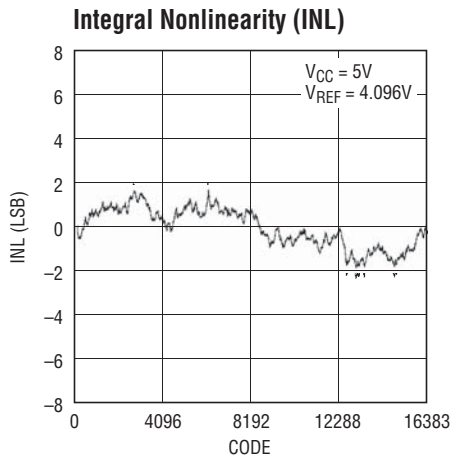

2600 G28

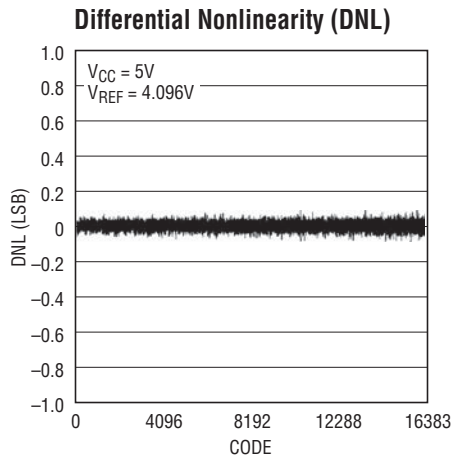

2600 G29

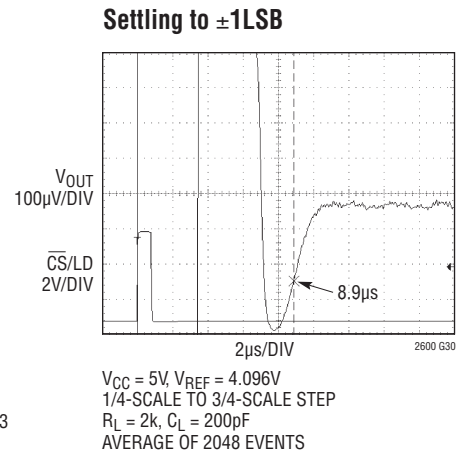

## LTC2620

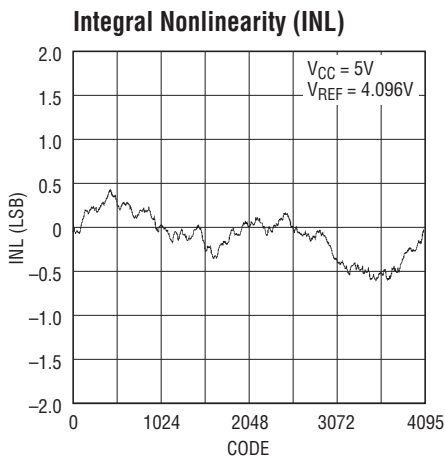

2600 G31

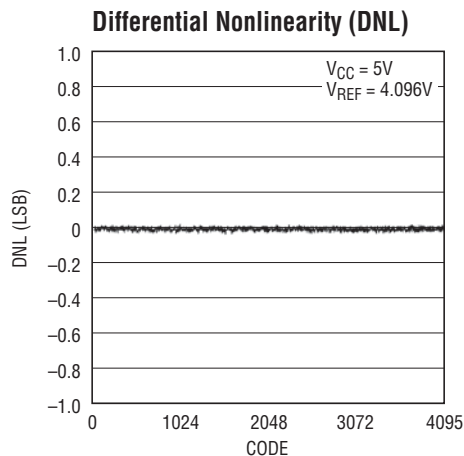

2600 G32

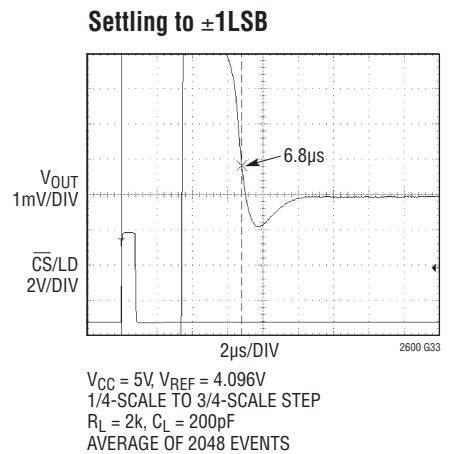

## LTC2600/LTC2610/LTC2620

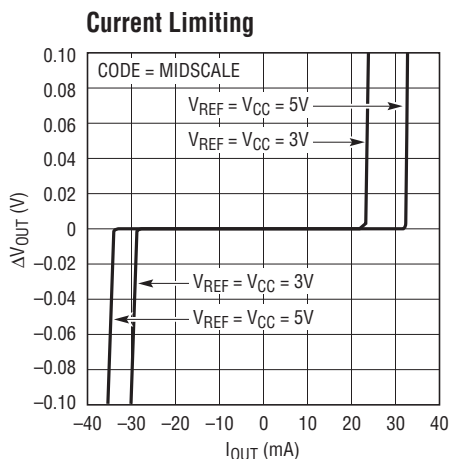

2600 G01

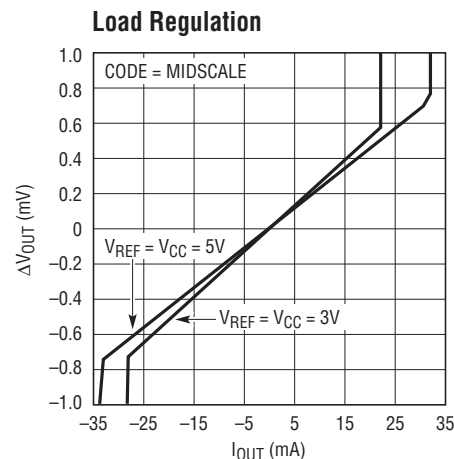

2600 G02

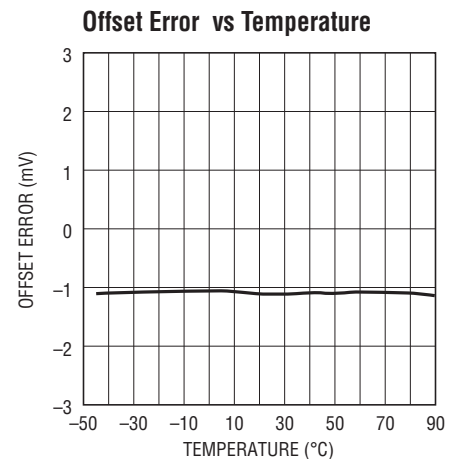

2600 G03

## TYPICAL PERFORMANCE CHARACTERISTICS

LTC2600/LTC2610/LTC2620

Zero-Scale Error vs Temperature

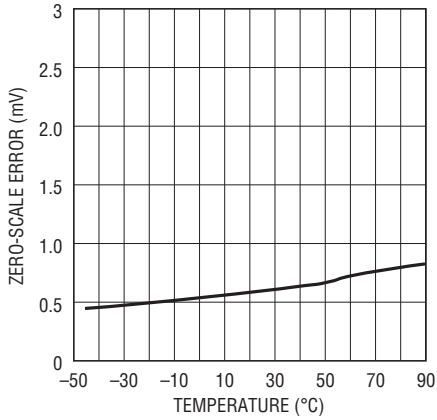

2600 G04

Gain Error vs Temperature

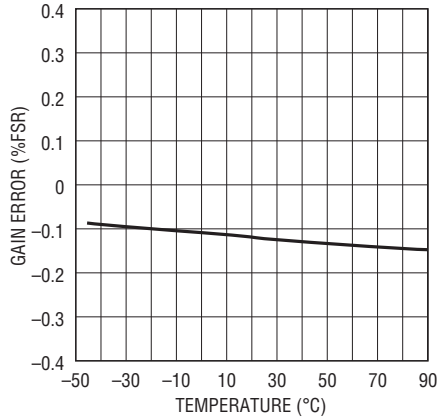

2600 G05

Offset Error vs V<sub>CC</sub>

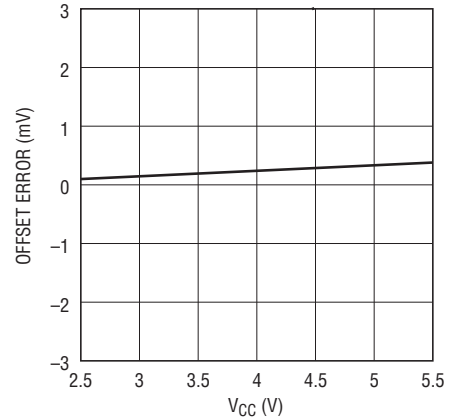

2600 G06

Gain Error vs V<sub>CC</sub>

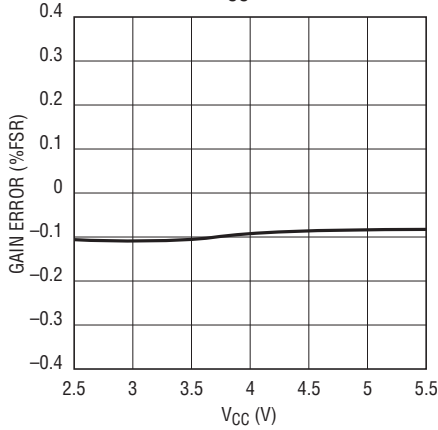

2600 G07

I<sub>CC</sub> Shutdown vs V<sub>CC</sub>

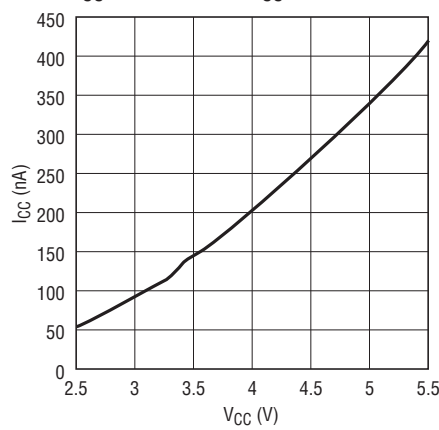

2600 G08

Large-Signal Response

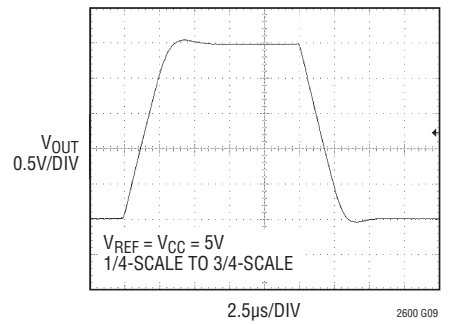

2600 G09

Mid-Scale Glitch Impulse

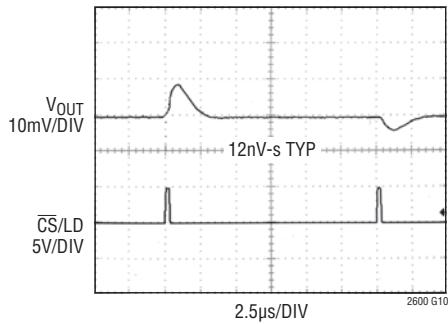

2600 G10

Power-On Reset Glitch

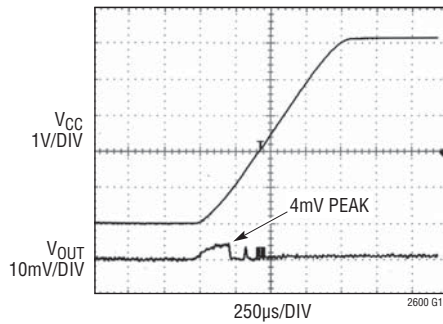

2600 G11

Headroom at Rails vs Output Current

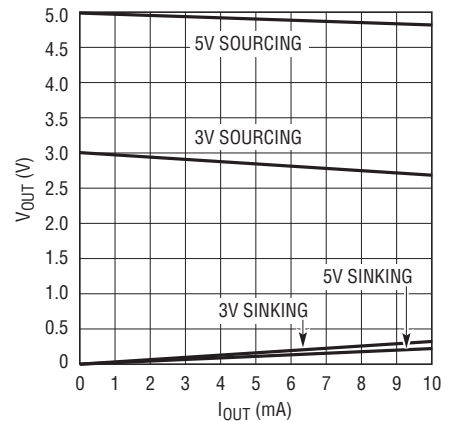

2600 G12



# TYPICAL PERFORMANCE CHARACTERISTICS

LTC2600/LTC2610/LTC2620

**Supply Current vs Logic Voltage**

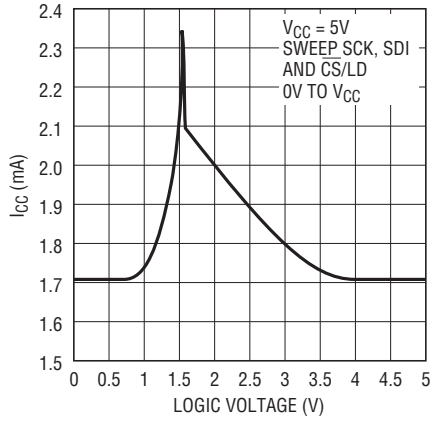

2600 G13

**Exiting Power-Down to Mid-Scale**

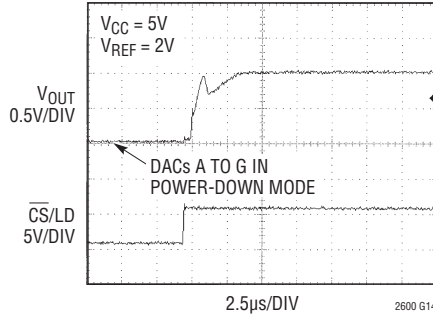

2600 G14

**Hardware CLR**

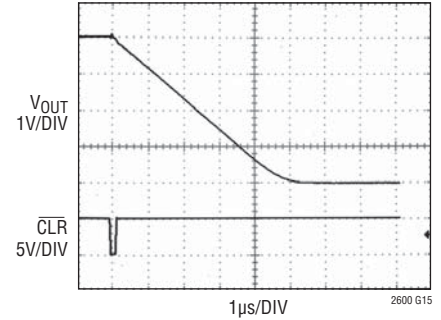

2600 G15

**Multiplying Bandwidth**

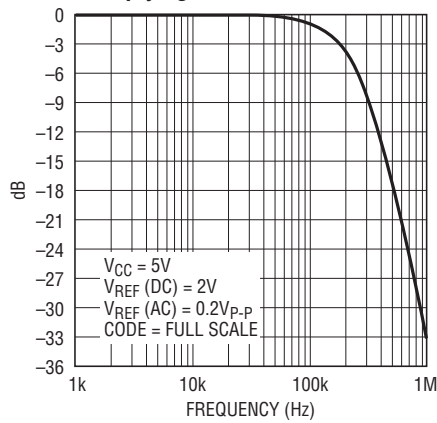

2600 G16

**Output Voltage Noise, 0.1Hz to 10Hz**

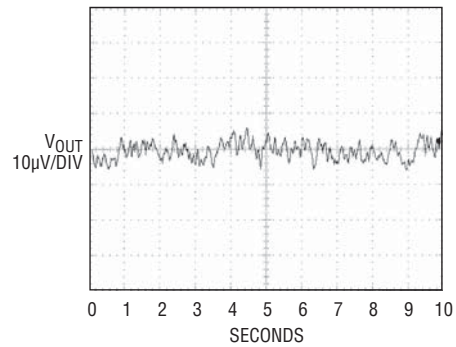

2600 G17

**Short-Circuit Output Current vs  $V_{OUT}$  (Sinking)**

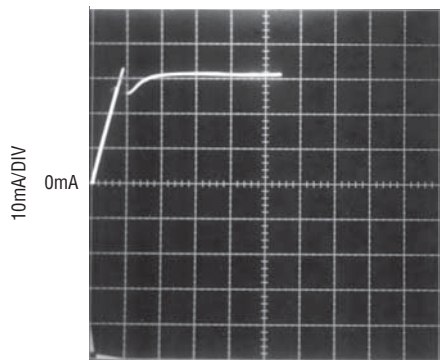

$V_{CC} = 5.5V$   
 $V_{REF} = 5.6V$   
CODE = 0  
 $V_{OUT}$  SWEPT 0V TO  $V_{CC}$

2600 G18

**Short-Circuit Output Current vs  $V_{OUT}$  (Sourcing)**

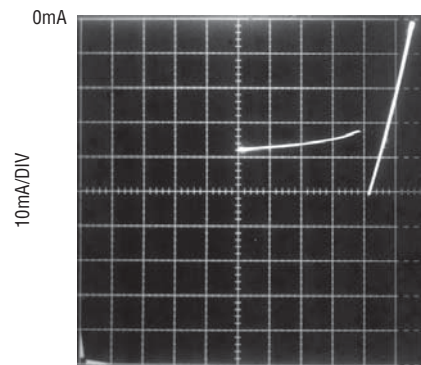

$V_{CC} = 5.5V$   
 $V_{REF} = 5.6V$   
CODE = FULL SCALE  
 $V_{OUT}$  SWEPT  $V_{CC}$  TO 0V

2600 G19

**PIN FUNCTIONS** (GN/UFD)

**GND (Pin 1/Pin 20):** Analog Ground.

**V<sub>OUTA</sub> to V<sub>OUTH</sub> (Pins 2-5 and 12-15/Pins 1-48 and 13-16):** DAC Analog Voltage Outputs. The output range is  $0 - V_{REF}$ .

**REF (Pin 6/Pin 5):** Reference Voltage Input.  $0V \leq V_{REF} \leq V_{CC}$ .

**$\overline{CS/LD}$  (Pin 7/Pin 7):** Serial Interface Chip Select/Load Input. When  $\overline{CS/LD}$  is low, SCK is enabled for shifting data on SDI into the register. When  $\overline{CS/LD}$  is taken high, SCK is disabled and the specified command (see Table 1) is executed.

**SCK (Pin 8/Pin 8):** Serial Interface Clock Input. CMOS and TTL compatible.

**SDI (Pin 9/Pin 9):** Serial Interface Data Input. Data is applied to SDI for transfer to the device at the rising edge of SCK. The LTC2600, LTC2610 and LTC2620 accept input word lengths of either 24 or 32 bits.

**SDO (Pin 10/Pin 10):** Serial Interface Data Output. This pin is used for daisychain operation. The serial output of the shift register appears at the SDO pin. The data transferred to the device via the SDI pin is delayed 32 SCK rising edges before being output at the next falling edge. SDO is an active output and does not go high impedance, even when  $\overline{CS/LD}$  is taken to a logic high level.

**$\overline{CLR}$  (Pin 11/Pin 11):** Asynchronous Clear Input. A logic low at this level-triggered input clears all registers and causes the DAC voltage outputs to drop to 0V. CMOS and TTL compatible.

**V<sub>CC</sub> (Pin 16/Pin 17):** Supply Voltage Input.  $2.5V \leq V_{CC} \leq 5.5V$ .

**DNC (Pins 6, 12, 18, 19 UFD Only):** Do Not Connect.

**Exposed Pad (Pin 21 UFD Only):** Ground. The exposed pad must be soldered to the PCB.

# BLOCK DIAGRAM

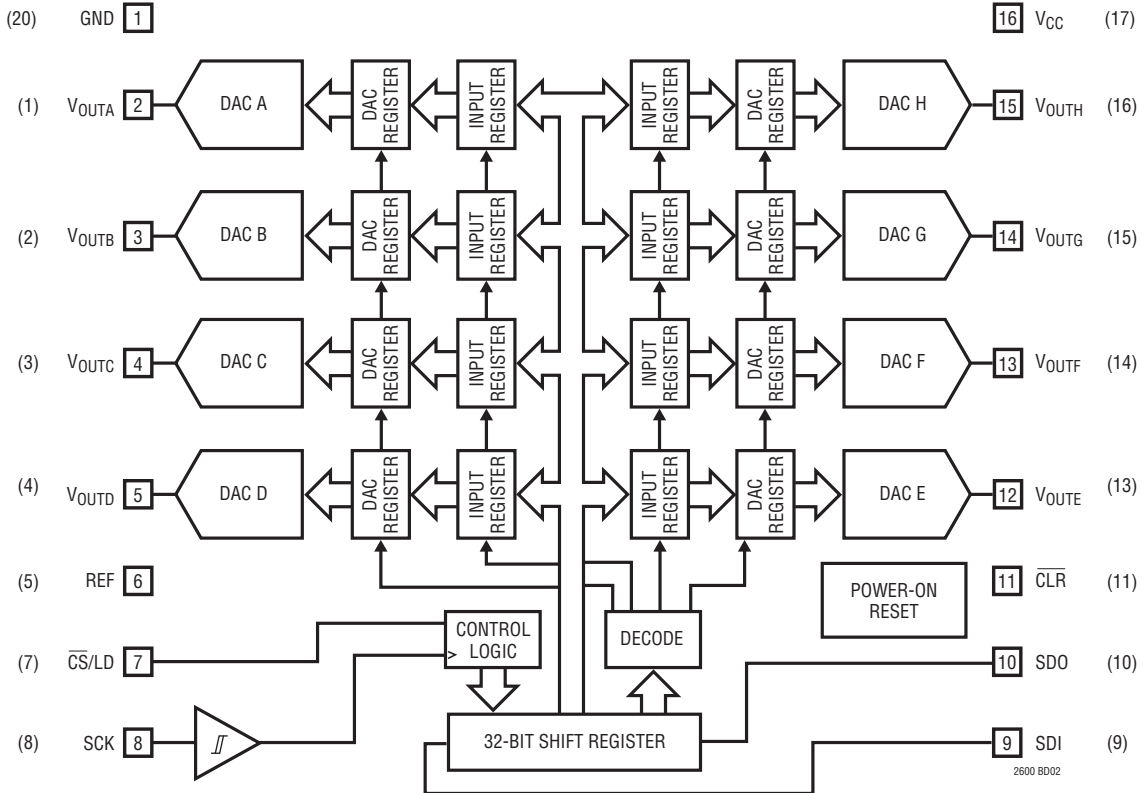

NOTE: NUMBERS IN PARENTHESIS REFER TO THE UFD PACKAGE

# TIMING DIAGRAM

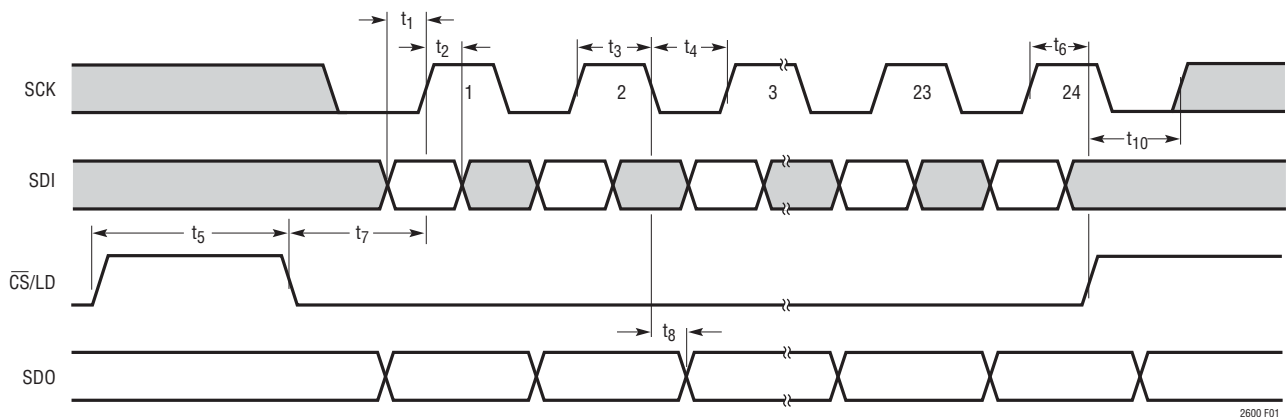

## OPERATION

### Power-On Reset

The LTC2600/LTC2610/LTC2620 clear the outputs to zero-scale when power is first applied, making system initialization consistent and repeatable.

For some applications, downstream circuits are active during DAC power-up, and may be sensitive to nonzero outputs from the DAC during this time. The LTC2600/2610/2620 contain circuitry to reduce the power-on glitch: the analog outputs typically rise less than 10mV above zero-scale during power on if the power supply is ramped to 5V in 1ms or more. In general, the glitch amplitude decreases as the power supply ramp time is increased. See Power-On Reset Glitch in the Typical Performance Characteristics section.

### Power Supply Sequencing

The voltage at REF (Pin 6) should be kept within the range  $-0.3V \leq V_{REF} \leq V_{CC} + 0.3V$  (see Absolute Maximum Ratings). Particular care should be taken to observe these limits during power supply turn-on and turn-off sequences, when the voltage at  $V_{CC}$  (Pin 16) is in transition.

### Transfer Function

The digital-to-analog transfer function is:

$$V_{OUT(IDEAL)} = \left( \frac{k}{2^N} \right) V_{REF}$$

where k is the decimal equivalent of the binary DAC input code, N is the resolution and  $V_{REF}$  is the voltage at REF (Pin 6).

Table 1.

COMMAND*				
C3	C2	C1	C0	
0	0	0	0	Write to Input Register n
0	0	0	1	Update (Power Up) DAC Register n
0	0	1	0	Write to Input Register n, Update (Power Up) All n
0	0	1	1	Write to and Update (Power Up) n
0	1	0	0	Power Down n
1	1	1	1	No Operation

\*Command and address codes not shown are reserved and should not be used.

### Serial Interface

The  $\overline{CS}/LD$  input is level triggered. When this input is taken low, it acts as a chip-select signal, powering on the SDI and SCK buffers and enabling the input shift register. Data (SDI input) is transferred at the next 24 rising SCK edges. The 4-bit command, C3-C0, is loaded first; then the 4-bit DAC address, A3-A0; and finally the 16-bit data word. The data word comprises the 16-, 14- or 12-bit input code, ordered MSB-to-LSB, followed by 0, 2 or 4 don't-care bits (LTC2600, LTC2610 and LTC2620 respectively). Data can only be transferred to the device when the  $\overline{CS}/LD$  signal is low. The rising edge of  $\overline{CS}/LD$  ends the data transfer and causes the device to carry out the action specified in the 24-bit input word. The complete sequence is shown in Figure 2a.

The command (C3-C0) and address (A3-A0) assignments are shown in Table 1. The first four commands in the table consist of write and update operations. A write operation loads a 16-bit data word from the 32-bit shift register into the input register of the selected DAC, n. An update operation copies the data word from the input register to the DAC register. Once copied into the DAC register, the data word becomes the active 16-, 14- or 12-bit input code, and is converted to an analog voltage at the DAC output. The update operation also powers up the selected DAC if it had been in power-down mode. The data path and registers are shown in the Block Diagram.

While the minimum input word is 24 bits, it may optionally be extended to 32 bits. To use the 32-bit word width, 8 don't-care bits are transferred to the device first, followed by the 24-bit word as just described. Figure 2b shows the

ADDRESS (n)*				
A3	A2	A1	A0	
0	0	0	0	DAC A
0	0	0	1	DAC B
0	0	1	0	DAC C
0	0	1	1	DAC D
0	1	0	0	DAC E
0	1	0	1	DAC F
0	1	1	0	DAC G
0	1	1	1	DAC H
1	1	1	1	All DACs

## OPERATION

### INPUT WORD (LTC2600)

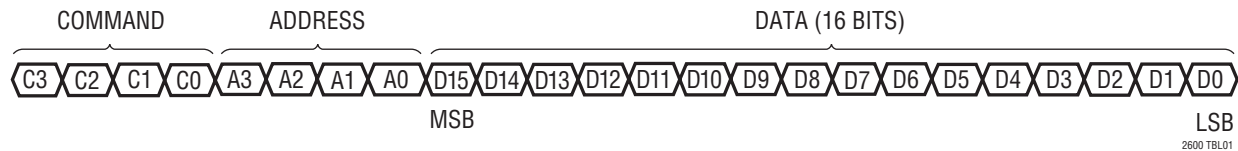

### INPUT WORD (LTC2610)

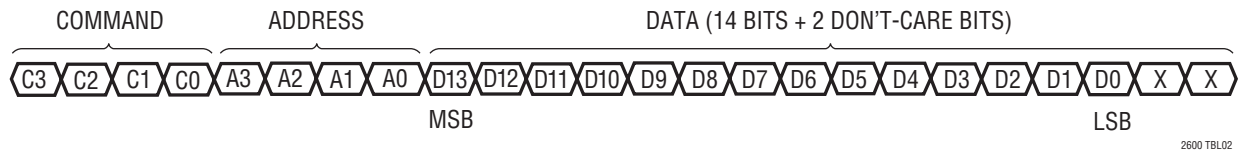

### INPUT WORD (LTC2620)

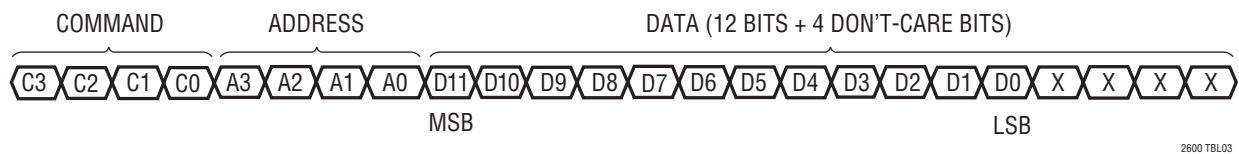

32-bit sequence. The 32-bit word is required for daisy-chain operation, and is also available to accommodate microprocessors which have a minimum word width of 16 bits (2 bytes).

### Daisychain Operation

The serial output of the shift register appears at the SDO pin. Data transferred to the device from the SDI input is delayed 32 SCK rising edges before being output at the next SCK falling edge.

The SDO output can be used to facilitate control of multiple serial devices from a single 3-wire serial port (i.e., SCK, SDI and  $\overline{CS/LD}$ ). Such a “daisychain” series is configured by connecting SDO of each upstream device to SDI of the next device in the chain. The shift registers of the devices

are thus connected in series, effectively forming a single input shift register which extends through the entire chain. Because of this, the devices can be addressed and controlled individually by simply concatenating their input words; the first instruction addresses the last device in the chain and so forth. The SCK and  $\overline{CS/LD}$  signals are common to all devices in the series.

In use,  $\overline{CS/LD}$  is first taken low. Then the concatenated input data is transferred to the chain, using SDI of the first device as the data input. When the data transfer is complete,  $\overline{CS/LD}$  is taken high, completing the instruction sequence for all devices simultaneously. A single device can be controlled by using the no-operation command (1111) for the other devices in the chain.

## OPERATION

### Power-Down Mode

For power-constrained applications, power-down mode can be used to reduce the supply current whenever less than eight outputs are needed. When in power-down, the buffer amplifiers and reference inputs are disabled, and draw essentially zero current. The DAC outputs are put into a high impedance state, and the output pins are passively pulled to ground through individual 90k resistors. When all eight DACs are powered down, the master bias generation circuit is also disabled. Input- and DAC-register contents are not disturbed during power-down.

Any channel or combination of channels can be put into power-down mode by using command 0100b in combination with the appropriate DAC address, (n). The 16-bit data word is ignored. The supply and reference currents are reduced by approximately 1/8 for each DAC powered down; the effective resistance at REF (Pin 6) rises accordingly, becoming a high impedance input (typically  $> 1\text{G}\Omega$ ) when all eight DACs are powered down.

Normal operation can be resumed by executing any command which includes a DAC update, as shown in Table 1. The selected DAC is powered up as its voltage output is updated.

There is an initial delay as the DAC powers up before it begins its usual settling behavior. If less than eight DACs are in a powered-down state prior to the update command, the power-up delay is 5 $\mu\text{s}$ . If, on the other hand, all eight DACs are powered down, then the master bias generation circuit is also disabled and must be restarted. In this case, the power-up delay is greater: 12 $\mu\text{s}$  for  $V_{\text{CC}} = 5\text{V}$ , 30 $\mu\text{s}$  for  $V_{\text{CC}} = 3\text{V}$ .

### Voltage Outputs

Each of the 8 rail-to-rail amplifiers contained in these parts has guaranteed load regulation when sourcing or sinking up to 15mA at 5V (7.5mA at 3V).

Load regulation is a measure of the amplifier's ability to maintain the rated voltage accuracy over a wide range of load conditions. The measured change in output voltage per milliampere of forced load current change is expressed in LSB/mA.

DC output impedance is equivalent to load regulation, and may be derived from it by simply calculating a change in units from LSB/mA to Ohms. The amplifiers' DC output impedance is 0.025 $\Omega$  when driving a load well away from the rails.

When drawing a load current from either rail, the output voltage headroom with respect to that rail is limited by the 25 $\Omega$  typical channel resistance of the output devices; e.g., when sinking 1mA, the minimum output voltage = 25 $\Omega \cdot 1\text{mA} = 25\text{mV}$ . See the graph Headroom at Rails vs Output Current in the Typical Performance Characteristics section.

The amplifiers are stable driving capacitive loads of up to 1000pF.

### Board Layout

The excellent load regulation and DC crosstalk performance of these devices is achieved in part by keeping "signal" and "power" grounds separated internally and by reducing shared internal resistance to just 0.005 $\Omega$ .

## OPERATION

The GND pin functions both as the node to which the reference and output voltages are referred and as a return path for power currents in the device. Because of this, careful thought should be given to the grounding scheme and board layout in order to ensure rated performance.

The PC board should have separate areas for the analog and digital sections of the circuit. This keeps digital signals away from sensitive analog signals and facilitates the use of separate digital and analog ground planes which have minimal capacitive and resistive interaction with each other.

Digital and analog ground planes should be joined at only one point, establishing a system star ground as close to the device's ground pin as possible. Ideally, the analog ground plane should be located on the component side of the board, and should be allowed to run under the part to shield it from noise. Analog ground should be a continuous and uninterrupted plane, except for necessary lead pads and vias, with signal traces on another layer.

The GND pin of the part should be connected to analog ground. Resistance from the GND pin to system star ground should be as low as possible. Resistance here will

add directly to the effective DC output impedance of the device (typically  $0.025\Omega$ ), and will degrade DC crosstalk. Note that the LTC2600/LTC2610/LTC2620 are no more susceptible to these effects than other parts of their type; on the contrary, they allow layout-based performance improvements to shine rather than limiting attainable performance with excessive internal resistance.

### Rail-to-Rail Output Considerations

In any rail-to-rail voltage output device, the output is limited to voltages within the supply range.

Since the analog outputs of the device cannot go below ground, they may limit for the lowest codes as shown in Figure 3b. Similarly, limiting can occur near full scale when the REF pin is tied to  $V_{CC}$ . If  $V_{REF} = V_{CC}$  and the DAC full-scale error (FSE) is positive, the output for the highest codes limits at  $V_{CC}$  as shown in Figure 3c. No full-scale limiting can occur if  $V_{REF}$  is less than  $V_{CC} - \text{FSE}$ .

Offset and linearity are defined and tested over the region of the DAC transfer function where no output limiting can occur.

OPERATION

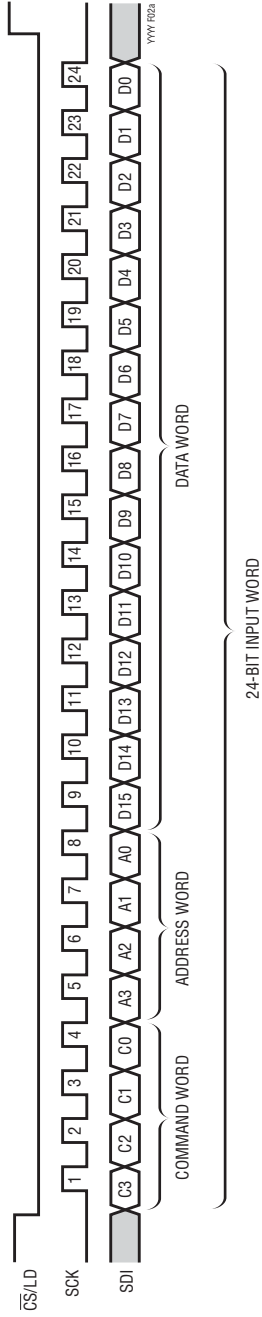

**Figure 2a. LTC2600 24-Bit Load Sequence (Minimum Input Word).**  
**LTC2610 SDI Data Word: 14-Bit Input Code + 2 Don't-Care Bits;**  
**LTC2620 SDI Data Word: 12-Bit Input Code + 4 Don't-Care Bits**

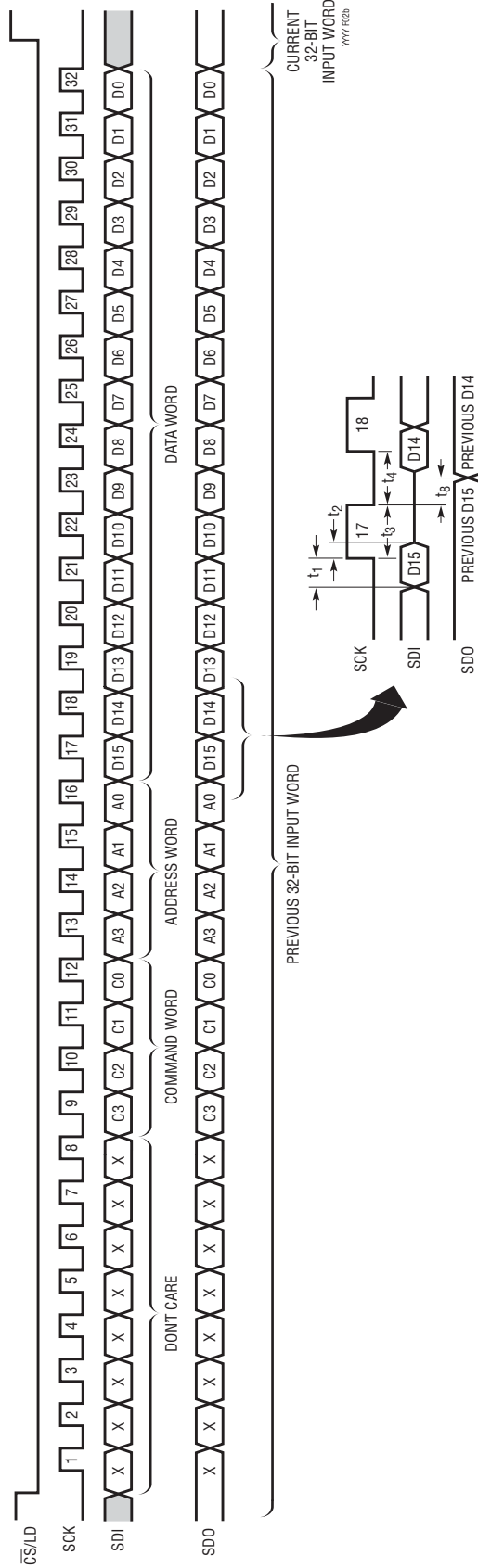

**Figure 2b. LTC2600 32-Bit Load Sequence (Required for Daisy-Chain Operation).**  
**LTC2610 SDI/SDO Data Word: 14-Bit Input Code + 2 Don't-Care Bits;**  
**LTC2620 SDI/SDO Data Word: 12-Bit Input Code + 4 Don't-Care Bits**



# OPERATION

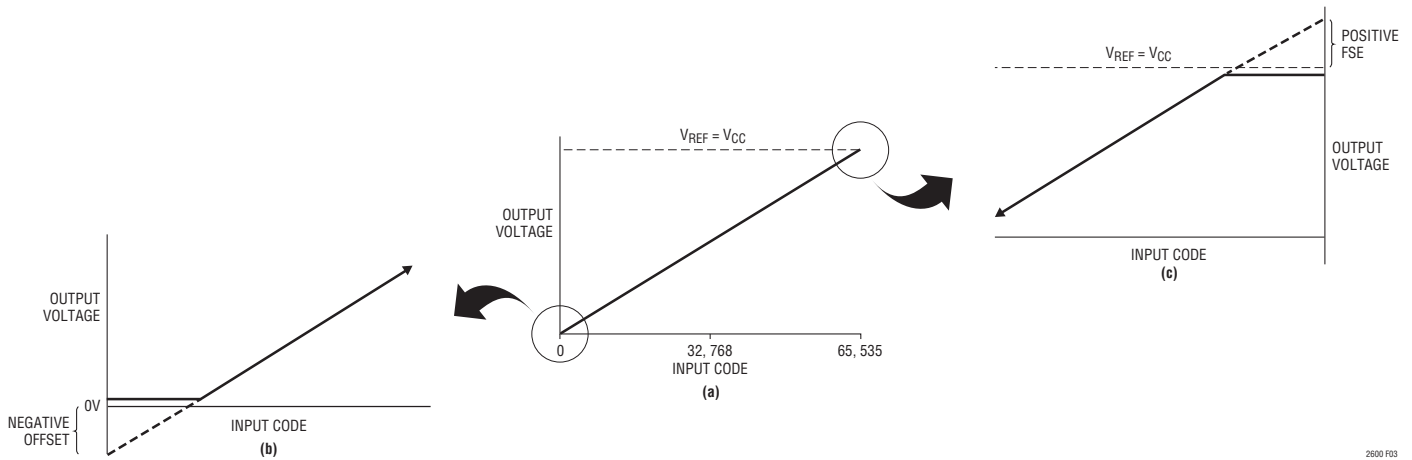
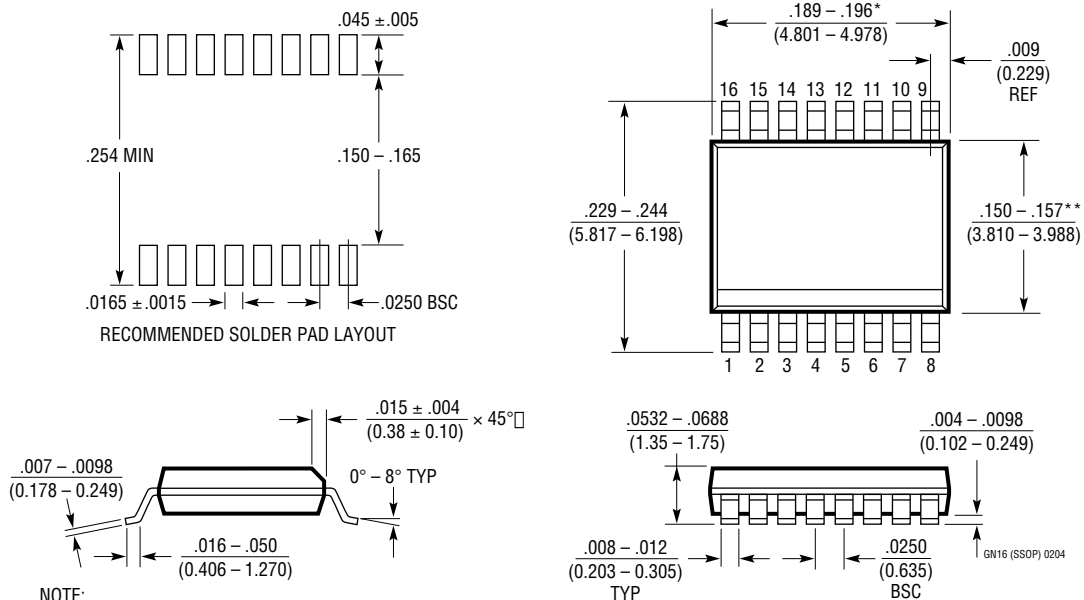

Figure 3. Effects of Rail-to-Rail Operation On a DAC Transfer Curve. (a) Overall Transfer Function (b) Effect of Negative Offset for Codes Near Zero-Scale (c) Effect of Positive Full-Scale Error for Codes Near Full Scale

# PACKAGE DESCRIPTION

## GN Package 16-Lead Plastic SSOP (Narrow .150 Inch) (Reference LTC DWG # 05-08-1641)



- NOTE:
1. CONTROLLING DIMENSION: INCHES
  2. DIMENSIONS ARE IN  $\frac{\text{INCHES}}{\text{MILLIMETERS}}$
  3. DRAWING NOT TO SCALE
- \*DIMENSION DOES NOT INCLUDE MOLD FLASH. MOLD FLASH SHALL NOT EXCEED 0.006" (0.152mm) PER SIDE
- \*\*DIMENSION DOES NOT INCLUDE INTERLEAD FLASH. INTERLEAD FLASH SHALL NOT EXCEED 0.010" (0.254mm) PER SIDE

## PACKAGE DESCRIPTION

**UFD Package**  
**20-Lead Plastic QFN (4mm × 5mm)**  
 (Reference LTC DWG # 05-08-1711 Rev B)

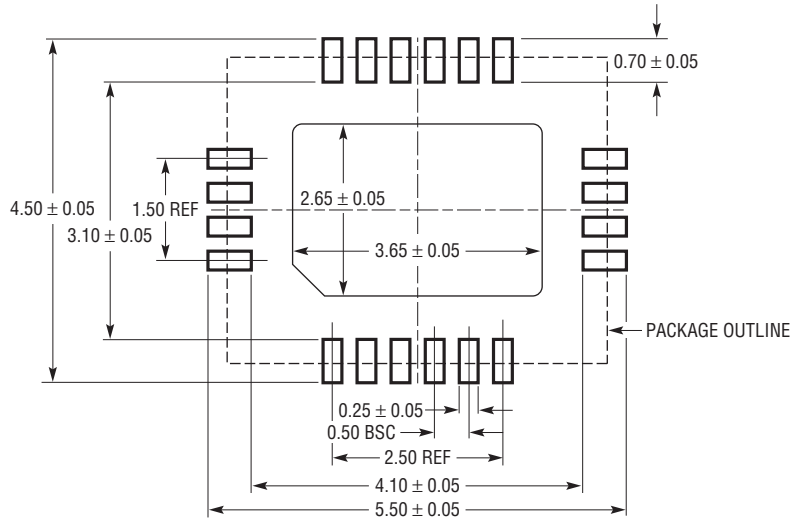

RECOMMENDED SOLDER PAD PITCH AND DIMENSIONS  
 APPLY SOLDER MASK TO AREAS THAT ARE NOT SOLDERED

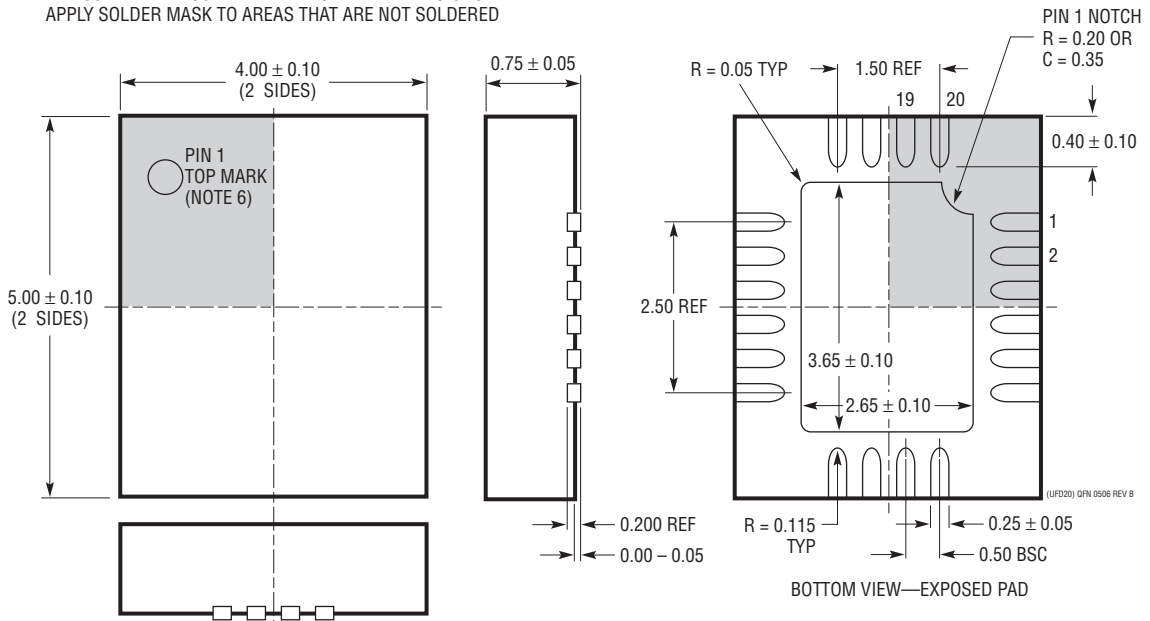

- NOTE:**
1. DRAWING PROPOSED TO BE MADE A JEDEC PACKAGE OUTLINE MO-220 VARIATION (WXXX-X).
  2. DRAWING NOT TO SCALE
  3. ALL DIMENSIONS ARE IN MILLIMETERS
  4. DIMENSIONS OF EXPOSED PAD ON BOTTOM OF PACKAGE DO NOT INCLUDE MOLD FLASH. MOLD FLASH, IF PRESENT, SHALL NOT EXCEED 0.15mm ON ANY SIDE
  5. EXPOSED PAD SHALL BE SOLDER PLATED
  6. SHADED AREA IS ONLY A REFERENCE FOR PIN 1 LOCATION ON THE TOP AND BOTTOM OF PACKAGE

**REVISION HISTORY** (Revision history begins at Rev D)

REV	DATE	DESCRIPTION	PAGE NUMBER
D	03/10	Revise GN Part Markings in Order Information	2
E	05/10	Changed "No Connect" pins to "Do Not Connect" in Pin Configuration and Pin Functions sections	2, 10

## TYPICAL APPLICATION

Schematic for LTC2600 Demonstration Circuit DC579. The Outputs Are Measured by an Onboard LTC2428

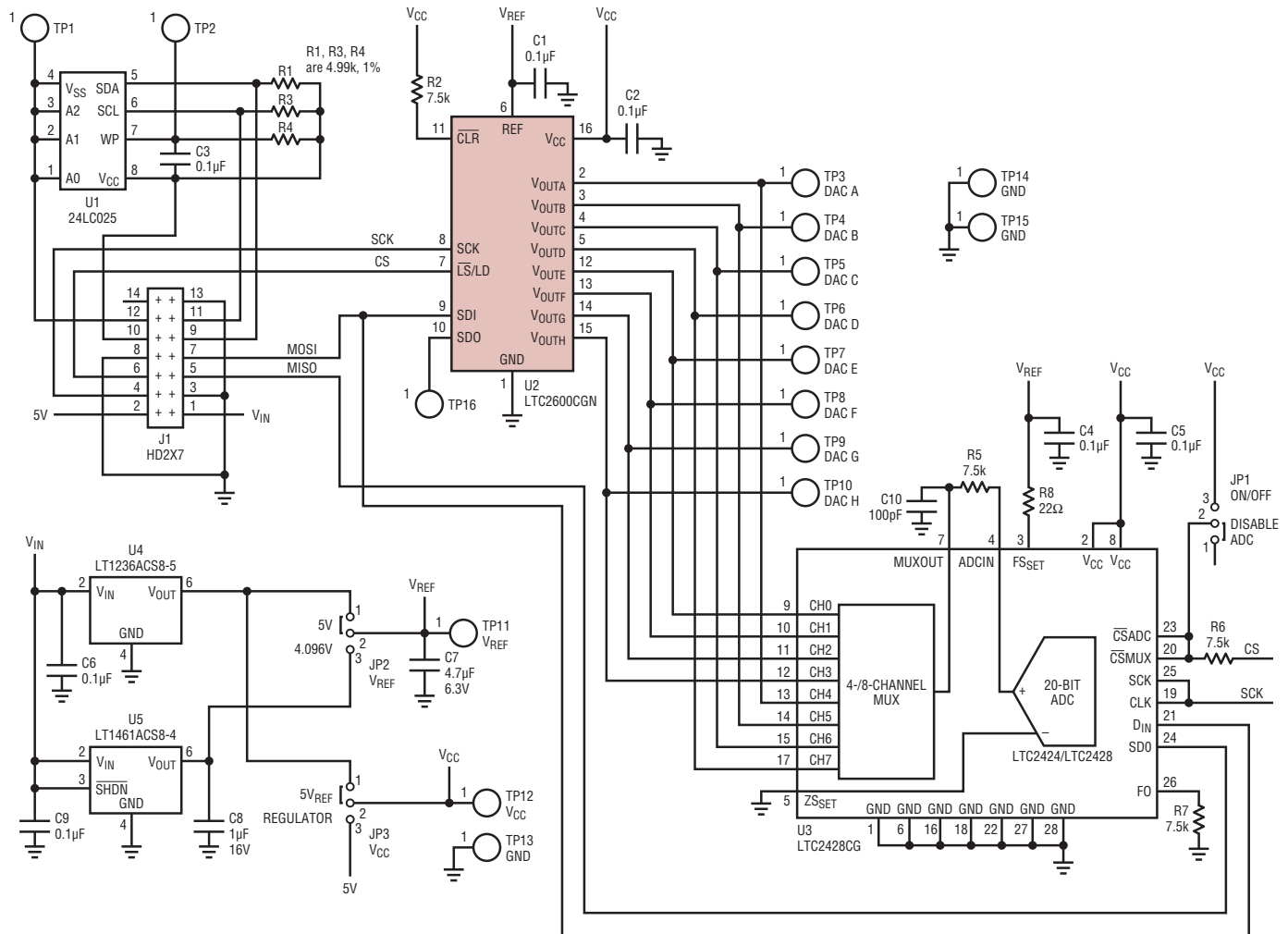

## RELATED PARTS

PART NUMBER	DESCRIPTION	COMMENTS
LTC1458/LTC1458L	Quad 12-Bit Rail-to-Rail Output DACs with Added Functionality	LTC1458: $V_{CC} = 4.5V$ to $5.5V$ , $V_{OUT} = 0V$ to $4.096V$ LTC1458L: $V_{CC} = 2.7V$ to $5.5V$ , $V_{OUT} = 0V$ to $2.5V$
LTC1654	Dual 14-Bit Rail-to-Rail $V_{OUT}$ DAC	Programmable Speed/Power, $3.5\mu s/750\mu A$ , $8\mu s/450\mu A$
LTC1655/LTC1655L	Single 16-Bit $V_{OUT}$ DAC with Serial Interface in SO-8	$V_{CC} = 5V(3V)$ , Low Power, Deglitched
LTC1657/LTC1657L	Parallel 5V/3V 16-Bit $V_{OUT}$ DAC	Low Power, Deglitched, Rail-to-Rail $V_{OUT}$
LTC1660/LTC1665	Octal 10/8-Bit $V_{OUT}$ DAC in 16-Pin Narrow SSOP	$V_{CC} = 2.7V$ to $5.5V$ , Micropower, Rail-to-Rail Output
LTC1821	Parallel 16-Bit Voltage Output DAC	Precision 16-Bit Settling in $2\mu s$ for 10V Step